

PER:  
FOR:

## FICHET (F)

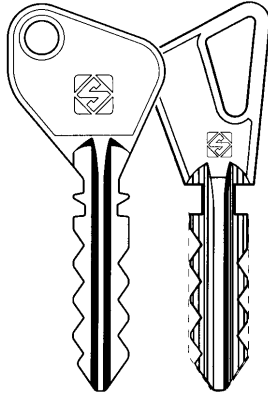

FT5C

FT4C

FT4

OPTIONAL

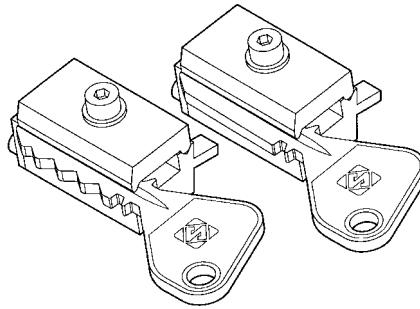

### D711513ZB

Adaptors for FT4-FT4C-FT5C keys  
Adattatori per chiavi FT4-FT4C-FT5C  
Adapters für FT4-FT4C-FT5C Schlüssel  
Adaptateurs pour clés FT4-FT4C-FT5C  
Adaptadores para llaves FT4-FT4C-FT5C

PER:  
FOR:

## CHRYSLER (USA)

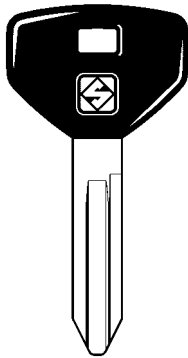

CY19P CY19

BRIGGS & STRATTON (USA)

OPTIONAL



### D709576ZB

Pair of shims  
Coppia spessori  
Passtücke  
Jeu de cales  
Par de chapas de espesor

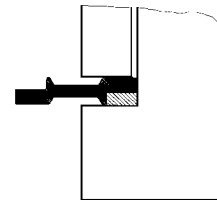
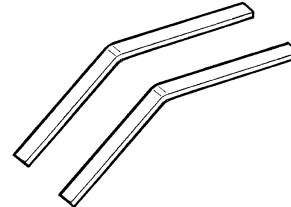

PER:  
FOR:

## CITROËN (F)



SX9CP

SX9GP

SX9T14

SX9AP

SX11BP

SX10BP

SX9T6

VALEO - SIMPLEX (F)

OPTIONAL

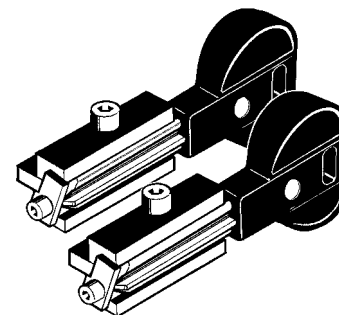

### D707754ZB

Adaptors for SIMPLEX keys  
Adattatori per chiavi SIMPLEX  
Adapters für SIMPLEX Schlüssel  
Adaptateurs pour clés SIMPLEX  
Adaptadores para llaves SIMPLEX

PER: **FORD (USA)**

FOR:

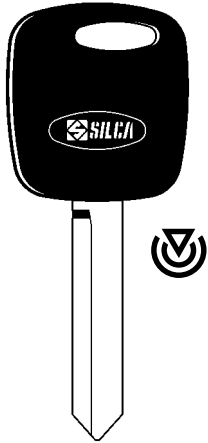

FO26T3    FO30    FO37R  
FO26    FO35    FO39  
FO39CP

OPTIONAL



**D712944ZB**

*Tip stop for extra long keys  
Fermo in punta per chiavi extra lunghe  
Kopfanschlag für Länge Schlüssel  
Cale en pointe pour clés longueur  
Tope en la punta para llaves largas*

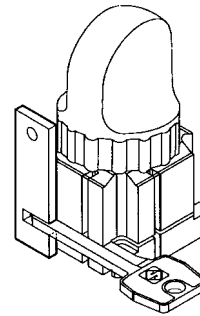

PER: **HYUNDAI (J)**

FOR:

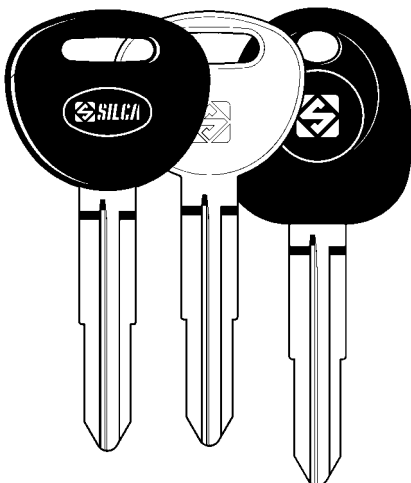

HYN10BP    HYN10    HYN10T4

OPTIONAL



**D709576ZB**

*Pair of shims  
Coppia spessori  
Passtücke  
Jeu de cales  
Par de chapas de espesor*

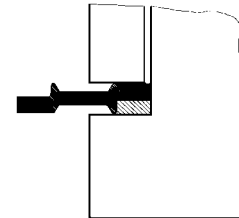
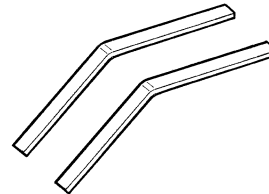

PER: **NISSAN (J)**

FOR:

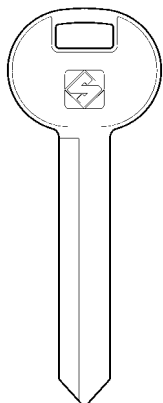

NSN13  
NSN14  
NSN14CP  
NSN16RBP

OPTIONAL



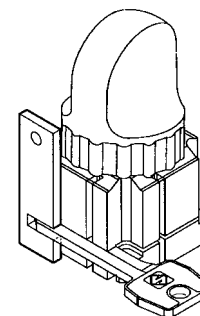

**D712944ZB**

*Tip stop for extra long keys  
Fermo in punta per chiavi extra lunghe  
Kopfanschlag für Länge Schlüssel  
Cale en pointe pour clés longueur  
Tope en la punta para llaves largas*

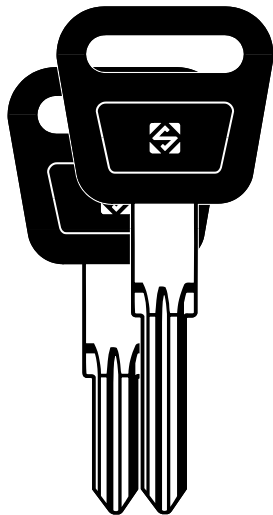

PER:  
FOR: **PORSCHE (D)**



   
HU42P HU45P  
HUF (D)

OPTIONAL



**D705474ZB**

Adaptors for HU42P-HU45P keys  
Adattatori per HU42P-HU45P  
Adapters für HU42P-HU45P Schlüssel  
Adaptateur pour clés HU42P-HU45P  
Adaptadores para llaves HU42P-HU45P

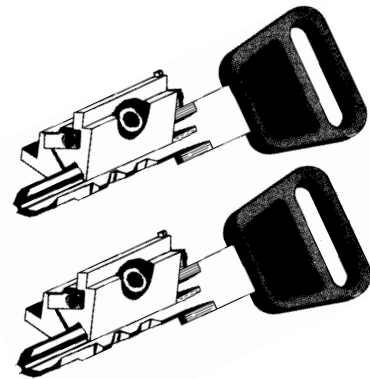

PER:  
FOR: **PAPAIZ (BR)**

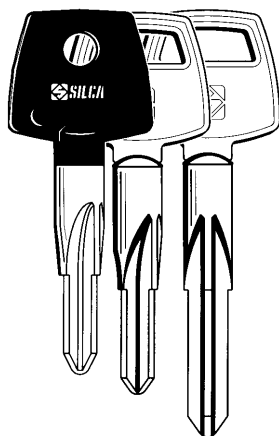

    
XPZ3P XPZ1 XPZ2

OPTIONAL



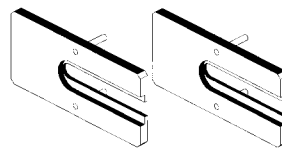

**D709830ZB**

Adaptors for PAPAIZ keys  
Adattatori per chiavi PAPAIZ  
Adapters für PAPAIZ Schlüssel  
Adaptateurs pour clés PAPAIZ  
Adaptadores para llaves PAPAIZ

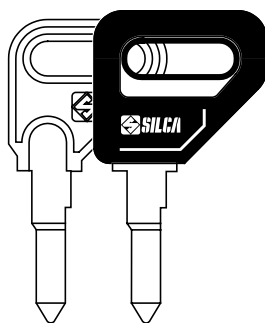

PER:  
FOR: **RENAULT (F)**



   
NE33S NE33SP  
VALEO - NEIMAN (F)

OPTIONAL



**D701813ZB**

Adaptors for NE33S-VAC64S keys  
Adattatori per chiavi NE33S-VAC64S  
Adapters für NE33S-VAC64S Schlüssel  
Adaptateurs pour clés NE33S-VAC64S  
Adaptadores para llaves NE33S-VAC64S

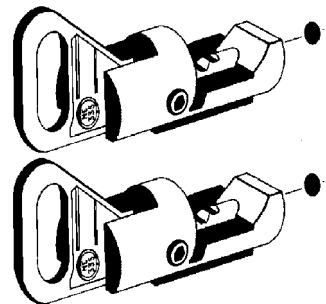

PER:  
FOR:

**RENAULT (F)**

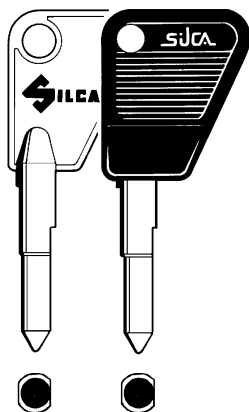

VAC64S VAC64SP  
VACHETTE (F)

OPTIONAL

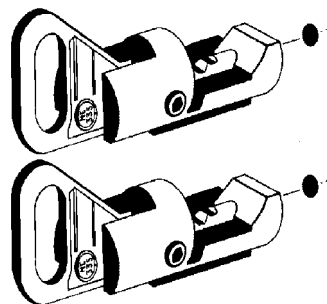

**D701813ZB**

*Adaptors for NE33S-VAC64S keys  
Adattatori per chiavi NE33S-VAC64S  
Adapters für NE33S-VAC64S Schlüssel  
Adaptateurs pour clés NE33S-VAC64S  
Adaptadores para llaves NE33S-VAC64S*

**ATTENTION:** for repairs or replacement of parts for maintenance, the 'CE' mark is guaranteed only if original spare parts provided by the manufacturer are used.

**ATTENZIONE:** in caso di riparazioni o sostituzione di pezzi per manutenzione, la marcatura "CE" è garantita solo se vengono utilizzate parti di ricambio originali fornite dal costruttore.

**ACHTUNG:** bei Reparaturen oder Auswechseln von Teilen zur Instandhaltung wird die CE-Markierung nur bei Verwendung von vom Hersteller gelieferten Originalersatzteilen gewährleistet.

**ATTENTION:** si vous effectuez des réparations ou que vous remplacez des pièces pendant un entretien, le marquage "CE" n'est garanti que si vous utilisez des pièces de rechange originales fournies par le fabricant.

**ATENCIÓN:** en caso de reparaciones o sustituciones de las piezas por mantenimiento, se garantiza la marca "CE" sólo si se utilizan partes de repuesto originales suministradas por el constructor.



**SILCA S.p.A.**

Via Podgora, 20 (Z.I.) 31029 VITTORIO VENETO (TV)

Tel. 0438 9136 Fax 0438 913800

[www.silca.it](http://www.silca.it)

Member of the Kaba Group

